

Health and Safety 101

RESOURCE GUIDE FOR ENGLISH LANGUAGE LEARNERS



**SAFE
WORK**

**S
A
F
E** SPOT THE HAZARD
ASSESS THE RISK
FIND A SAFER WAY
EVERYDAY



CONTENTS

Introduction	5
Benchmarks Levels 3 to 6	6
EAL classroom	6
Safety and Health Trainers	7
Acknowledgements	8
Artwork	8
Module 1: Safety Matters	9
Language Objectives for Safety Matters	10
Vocabulary	10
1. Thinking about Safety	10
2. Who's Who and What Do They Do?	13
3. Brainstorming Activity, the Results of Injury	14
4. Representatives	16
5. Discussion: Roles and Responsibilities	17
Exercise: workplace roles and responsibilities	18
Listening exercise	18
Learning from examples: reading and discussion	19
6. The Law	20
Module 2: Roles and Responsibilities	22
Language Objectives for Roles and Responsibilities	23
Vocabulary	23
1. Employer's Role	23
2. Supervisor's Role	25
3. Your Role	26
Activity 1: Roles and responsibilities	27
4. Asking Questions	29
Activity 2: Asking questions about safety issues (role play)	30
Activity 3: Vocabulary review	32
5. The Right to Refuse	34
Activities: Polite but firm!	35
Activity 4: Refusing work, jumbled dialogue	36
Activity 5: How to refuse work, reading a flowchart	37

Module 3: Work Hazards	39
Language Objectives for Work Hazards	40
Vocabulary	40
Types of workplace injury	41
Activity 1: Read and match. What type of hazard is it?	42
Activity 2: Hazards in different jobs	44
Activity 3: Integrated skills – making and presenting a hazards poster	48
1. WHMIS: Workplace Hazardous Materials Information System	49
WHMIS symbols	50
WHMIS product labels	50
Training	51
Activity 4: What are the WHMIS symbols and what do they represent?	52
Memory strategies	54
Effects of hazardous materials	55
Activity 5: Reading a WHMIS label	56
Activity 6: Reading – Material Safety Data Sheets	57
Activity 7: Lists game	58
Activity 8: Sean's story	60
Handout for Sean's story	60
Module 4: Work Safely	63
Language Objectives for Work Safely	64
Vocabulary	64
1. Controlling Hazards	64
i. Physical Hazards	64
Activity 1: Hazard alerts	66
ii. Chemical Hazards	67
iii. Ergonomic Hazard Control	68
iv. Biological Hazard Control	69
2. Protecting the Worker	70
Activity 1: Card games with PPE	70
Activity 2: Safety equipment review	74
Activity 3: A problem in the lab	75
3. Emergency!	75
Activity 4: Talking about emergencies	76
Activity 5: Reporting an emergency	77
Activity 6: Finding safety features	79
Activity 7: Reading and talking preventing injuries	80
4. What to Do When You are Hurt	81
Activity 8: What to do when you are hurt at work	82
Activity 9: Filing a claim	84
Activity 10: Discussion of working safely	87
Activity 11: Vocabulary review (reading and writing)	88
Activity 12: Pictorial vocabulary review	89



INTRODUCTION

INTRODUCTION



Workplace Safety and Health is important in all of its aspects. The consequences of ignoring hazards may be illness, injury, disability, even death and not knowing your rights can result in unnecessary hardships. Immigrant newcomers entering the Canadian workplace for the first time are particularly at risk.

Immigrants may not be familiar with the workplace equipment or environment, having come from a very different background. They may be overanxious to do the job well and take more risks than necessary. They may have trained for a completely different kind of work and are forced to accept whatever they can find in a competitive job market, at least until their language skills are up to par.

The objective of this new version of Health and Safety 101 on-line is to make it more accessible to language learners. The Manual is designed to help EAL instructors and safety trainers prepare newcomers to fully understand the safety and health training they receive in the workplace.

Benchmarks Levels 3 to 6

The website Health and Safety 101 is generally accessible to a CLB 6, as long as they have some assistance with terminology that is new to them. There may be references to specific jobs that are not familiar but the context and illustrations help to clarify each situation.

Lower benchmarks (4 and 5) will probably need more support. The 101 Resource Manual provides opportunities to introduce, practice and use the language they will need in the workplace. An abundance of illustrations is provided so that even at CLB 3 the basic safety concepts are made clear.

EAL classroom

Workplace content is finding its place in the generic EAL classroom because of the recent focus on essential skills. This new focus on Occupational Safety and Health permits workplace language to be introduced in a meaningful context, whether the learner is familiar with the workplace or not.



The objective of the EAL 101 Manual is to prepare learners to follow Manitoba's Health and Safety 101 on-line training program, to give them enough understanding of the basic concepts and the vocabulary used to permit them to follow the instruction and do the quizzes on the website. At the same time it offers practice in using the terminology in preparation for the safety and health training they will get in their respective workplaces. Many essential skills—oral and written skills, computer skills and even numeracy—are involved.

Instructors will be selective in what they choose to use from the manual. They may pass over some of the more advanced language and potentially confusing situations. For example, refusing work is best dealt with only if you become aware of a learner experiencing a dangerous situation. The details on legislation may only be of interest to specific learners. Certain hazards, such as fall protection or biological hazards, do not apply to many learners.

Safety and Health Trainers

The content of the 101 EAL Manual may help to clarify safety training to newcomer audiences. The illustrations and activities suggested here will help verify the learner's comprehension of the content of your specific training.

It is not the trainers' mandate to teach the English language to trainees. Nevertheless, sensitive support for learners will go a long way.

It seems simple enough to say, "If you don't understand, just ask." If the learner has doubts about who to approach, how to approach them and even how to word the question, they will choose not to ask. Oral activities and role play will reveal these needs and give a context in which to practice questioning skills.

Acknowledgements

The activities and suggestions in this manual were compiled and written by Lisa Petit. For their support and assistance in the preparation of these manuals, many thanks to the following people:

Anna Bird at Adult Language Training Branch,
Manitoba Department of Labour and Immigration.

Judy Fraser at Workplace Safety and Health,
Manitoba Department of Labour and Immigration.

Carol Hawkins, and the supportive members of MISI,
The Manitoba Immigrant Safety Initiative.

Melanie Olfert and Nuo Yang.

Lisa Allard, Lisa Reichert and Carla Woods at Work Start.

Gail Foote-Leylek at St. Boniface Hospital.

James Morden and Paul Urish at Palliser Furniture.

Linda Lalonde and Margaret Ko at International Centre.

Sylvia Thiessen, English at Work Coordinator, Pembina Valley.

Linda Karras, EAL workplace instructor.

Special thanks to Valerie Unwin at Palliser Furniture for proofreading the text and to all the instructors who gave their feedback and insights. Thank you!

Artwork

Many of the photos used in this Resource come from the MISI (Manitoba Immigrant Safety Initiative) collection and were taken at Palliser Furniture.

Others were provided by Manitoba's SAFE Work Program and Health and Safety 101, Workplace Safety and Insurance Board, Ontario.

Photos for People at Work are from Career Destinations Manitoba.

Another source throughout has been Microsoft Office Clipart.

Hazard Alert stories and illustrations are courtesy of Worksafe BC.

Story sequence artwork is by Lisa Petit.

The Health and Safety 101 Resource Guide is funded by Citizenship and Immigration Canada through the Manitoba Immigrant Integration Program.



MODULE 1

SAFETY MATTERS

MODULE 1: SAFETY MATTERS

This module will prepare learners to fully understand and participate in Module 1, Safety Matters on the Health and Safety 101 website. To access the website go to www.safemanitoba.com/programs.

If learners need help navigating the website, walk them through Getting Started.

Language Objectives for Safety Matters

- To introduce workplace people and their roles.
- To discuss why the workplace can be dangerous.
- To consider the costs of injuries.
- To know about the laws that protect workers.

Vocabulary

Employer, boss Employee, worker Supervisor Full time, part time, volunteer	incident injury illness death disability	to be aware of to prevent to protect to make sure, to ensure
roles and responsibilities to play a role to take part rights	representation to represent representative committee	the law covers, protects Act, legal, law to enforce fine

1. Thinking about Safety

To spark interest in the topic of Workplace Safety and Health, and to allow the instructor to get a sense of which areas are of most interest to the group, try this activity.

Lay out a selection of photos showing people at work. These can be easily found on Clip Art websites and in magazines. On the following pages, you will find a collection of pictures that show people at work as well as some of the hazards they deal with.

Encourage learners to select pictures depicting jobs they have done or are interested in doing here in Canada. If they have never had a job themselves, ask about their family members.



Have each learner explain why they chose the picture they did. Using the pictures, open a discussion about the risks involved in each type of employment. Ask the learners to rank the jobs they selected from least to most dangerous. Use blue tac to place the pictures in order or group them on the board. Encourage discussion while they are doing the activity.

Ask the group what they would like to know about Safety and Health in the Workplace in Canada. Take note of their questions. Tell them that over the course of these lessons, they will learn about *how to deal with dangers*, and *how the law protects them* in the workplace.

Suggestion: Enlarge the pictures and keep them up around the room during the training. They will come in handy again!

For more photos of people at work, go to Manitoba Career Destinations http://www.immigrantsandcareers.mb.ca/cdmb-newcomers/context/tag-pi-1211822033_1086.html

The site contains many more photos of immigrants at work in Manitoba.



Photos used with the permission of Manitoba Labour and Immigration and Don Present.



Photos courtesy of SAFE Manitoba and Health and Safety 101, Workplace Safety and Insurance Board, Ontario.



2. Who's Who and What Do They Do?



The Boss (The Employer)

What do employers do?

They pay the workers.

They manage the business.

They write **company policy**.

They decide on the **rules and regulations**.

They decide what **procedures** workers must follow.



The Supervisor

What do supervisors do?

They often **train** new workers.

They **demonstrate** how to do the job.

They show workers how to work safely.

They **watch** the workers to make sure they are doing the job properly.

They answer the worker's questions.



The Worker (Employee)

What do workers do?

They **take training**.

They **follow instructions**.

They **do the work**.

They are **paid** for their work.

3. Brainstorming Activity, the Results of Injury

Teacher's Notes for the Brainstorming Activity:

You may want to make the brainstorming entirely oral or you might prefer to chart out the different effects on the board as the students speak. Another option is to give each small group their own flip chart to map out the effects.

Use the following hints only if the learners' ideas seem to be drying up.

How does an injury affect you? Loss of income, pain, not able to move. Think of different kinds of injury, including disability and even death.

How does injury affect your family? How do they feel when they see you suffering? Does loss of income affect the family? Think of the added stress and responsibility.

How does your injury affect your community? That duties do you have in the community? Are people counting on you? Do you belong to a team that needs you?

How does your injury affect your workplace? Does your employer lose money? Your workstation is not running while you are away. How do your co-workers feel? Are they anxious about their own safety? Do they have to work overtime while you are away?

Incidents can cause...

Damage 	Injury 	Illness 
Disability 	Loss of Income 	Death 



If you have an injury at work, it doesn't only affect you.



Your family



Your co-workers

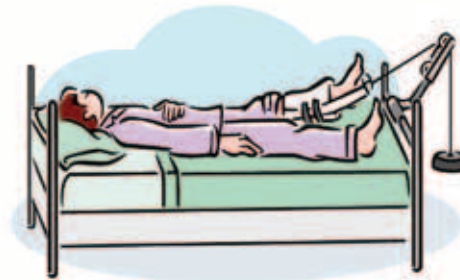

You



Your community



Your employer

4. Representatives

A **representative** is one person who is chosen to speak for many others. We elect representatives to our government.

A **committee** is a group of people who are chosen to speak and to make decisions for others.



Representative



Committee

In the workplace, **representatives** are chosen to look out for the safety of the workers. In large companies there are safety and health **committees**.

Which topics do you think this Safety and Health Committee might be discussing?

- 1. Where to put the new First Aid station.
- 2. How to improve the lunch menu.
- 3. Check out some new PPE that is for sale.
- 4. How the boss should select vacation time requests.
- 5. What to do about a forklift driver. He allows workers to fool around and ride on the forklifts.
- 6. When electrical wiring should be inspected.
- 7. How much to charge for the company picnic.



Answers: 1, 3, 5, 6



5. Discussion: Roles and Responsibilities

		
In the family, a family member usually has the role of caring for children.	The family member may go out to work to make money to support the family.	Children may also have a role to play. For example taking care of the pets.

Talking about roles and responsibilities.

- What other **roles** do the members of a family play?
- What other **responsibilities** do they have?
- Are roles and responsibilities different in different families?
- Are they different in different countries?
- Who **enforces** the rules?
- What responsibilities do drivers have? (**follow the law, respect** others)
- What role does a teacher play? (plan, teach, **encourage** practice, observe)
- What is a policeman's role? (watch, enforce)
- Who makes the **rules and regulations** at work?
- Who decides company **policies and procedures** in the workplace?
- In the workplace, who **enforces** the safety rules?

(Within the workplace, the employer enforces the rules. The Safety and Health Officer from the government Regional Safety and Health enforces the rules that the employer must follow.)

Exercise: workplace roles and responsibilities

worker • employer • supervisor

Health & Safety Representatives • Health & Safety Officer

Fill in the blanks with the correct person

1. The _____ makes sure that new employees are trained.
2. The _____ shows the worker how to do his/her job safely.
3. The _____ must follow company procedures.
4. The _____ enforces the law.
5. The _____ speaks for the workers.
6. The _____ makes sure that the new worker understands the training.
7. The _____ can inspect the workplace at any time.

Answers:

1. employer 2. supervisor 3. worker 4. H&S officer 5. H&S representative 6. supervisor 7. H&S officer

Listening Exercise

Which of the following words is your teacher saying? Listen to the endings of the words. Underline the word you hear.

Employer	Employee
Injury	Injuries
Trainer	Trainee
*Incident	Accident
Prevented	Prevention
Represented	Representative

Note: Safety and Health will use the word *incident* rather than *accident*.



Learning from Examples: Reading and Discussion

How can I “participate”?

Under the law, you also have the right to participate. You have the right to take part in keeping your workplace healthy and safe. Some examples:

- Ask questions
- Help with safety and health inspections
- Take part in training
- Point out hazards and possible solutions
- Become a Safety and Health Representative or a member of the Joint Safety and Health Committee.

What is “fooling around”?



Joking and having fun is often called fooling around. A fool is someone who does comical, surprising things to make others laugh. Foolish also means stupid. In the workplace, where there are many hazards, it is stupid to fool around.

Some examples of fooling around:

- Wearing your PPE backwards
- More than one person riding on a forklift
- Using compressed air gun to “shoot” co-workers

What does “Policy” mean?

A policy is a belief or idea about how things should be done. Company policy is usually written up by the owners. Rules and regulations are based on the company’s policies.

Some examples of policies:

- All new workers must be trained in safety and health before starting work.
- If workers are absent without explanation three times, they will be given a warning. After that they may be fired.
- Workers who ask for shift changes because they want to attend training should be allowed if possible.

What is a “Procedure”?

A procedure tells you how things are done. It tells you how to “proceed” step by step with your work. What do you do first? How do you get your tools and materials? How do you close down your station when you finish?

Safety and health procedures are important. They are the actions that keep you safe and that should always be part of your work routine. They should become habits.

Examples of procedures:

- Always put on your PPE before doing specific jobs.
- Lock machines before doing cleaning and repairing them.
- Regularly clean work areas to prevent slips and trips.
- Wash your hands after touching contaminated things.

6. The Law

Under the law, we all have certain responsibilities. For example, to drive a car you must have a license and you must **obey the rules** of the road. You must operate your car **properly**.

We all have **legal responsibilities**.



We also **have legal rights**. For example, the people who walk in the streets have a right to cross the street safely at a crosswalk. Drivers must **respect** that right.

In the workplace, we also have responsibilities. We must obey the rules and follow **company policies**. We must work safely and operate equipment properly.

We also have legal rights in the workplace; we have the right to work safely.



Workplace Safety and Health Law

In Manitoba, all workers are protected by the Workplace Safety and Health Act. In Module 2 of Health and Safety 101, you will learn about your **rights and responsibilities** under the law.





MODULE 2

ROLES AND RESPONSIBILITIES



MODULE 2: ROLES AND RESPONSIBILITIES

This module will prepare learners to fully understand and participate in Module 2, Roles and Responsibilities on the Health and Safety 101 website. To access the website go to www.safemanitoba.com/programs.

If learners need help navigating the website, walk them through Getting Started.

Language Objectives for Roles and Responsibilities

- Talk about roles and responsibilities in the workplace.
- Ask questions about workplace safety and health.
- Know how to refuse dangerous work.

Vocabulary

Law, legal cover protect	Have the responsibility to be responsible for Play a role, take part, participate Solve a problem, work it out	Hazards Safety equipment
policy procedures program	refuse refusal	

1. Employer's Role

Your employer is responsible for everyone's safety at work. He must do the following:

- Prepare a safety and health policy and program
- Provide training
- Provide information, instruction and supervision to keep you safe
- Make sure you have necessary safety equipment
- Provide information on hazards in the workplace



The employer keeps you informed:

- Posters
- Reminders
- New safety information
- Names of safety and health representatives
- First Aid information

Training

Your employer and supervisor must make sure you have proper safety training.

General training includes everything all the employees should know. This training may be done in a classroom with a Safety and Health Trainer.

- Company safety and health policy
- Company safety rules
- What to do in an emergency
- How to get first aid

Specific training tells you how to do your job safely. This training is probably done on the work site with your supervisor.

- How to handle hazardous materials
- How to use safety gear or Personal Protective Equipment (PPE)
- How to operate machinery and equipment safely





2. Supervisor's Role

Usually, your supervisor works closely with you every day. So he or she plays an important role in keeping you safe on the job. Your supervisor has legal responsibilities too. Your supervisor will make sure that you are following the law and the company's safety rules,



Your supervisor

...tells you about any job hazards or dangers,



...shows you how to do your job and answers your questions and



...makes sure you use safety equipment properly.

A good supervisor looks after workers. The supervisor should:

- work near or with the workers
- answer workers' questions
- let you know if the job is being well done or not
- provide hands-on training until you are confident you can do the job safely.
- see that you use the right safety equipment
- watch you to see that you are working safely

3. Your Role

You, the worker, have to do your part too. Here's what the law says you must do:

- Obey the law
- Use machines and equipment safely
- Wear your personal protective equipment (PPE)
- Work safely and don't fool around
- Report hazards to your boss

Report Hazards at Work

You must report hazards that you see at work. It is your legal responsibility. Think that someone might be hurt if you don't point out the danger. Try to recognize things that might be dangerous. If you're not sure, ask someone.

Ask yourself some key questions:

- Is any of the machinery broken?
- Are there any warning labels or signs?
- Is there any moving equipment I could get caught in?
- Is there a guard missing?
- Is there something I could trip on?
- Do I need protective equipment?
- Do I know how to do this job safely?

Protect yourself and others. Report hazards!





Activity 1: Roles and responsibilities

Employer	Supervisor	Worker
Provide the instruction and supervision workers need to do their job safely	Make sure that workers follow the law and the company's safety rules	Obey the law Obey the company's safety and health rules
Make sure workers have the necessary safety equipment	Make sure workers use safety equipment properly	Wear personal protective equipment (PPE)
Provide information on hazards in the workplace	Tell the worker about any job hazards or dangers	Report hazards to the supervisor
Provide safety information where everyone can see it	Show the worker how to operate equipment safely	Use equipment safely Work safely and don't fool around

Cut out the Roles and Responsibilities cards and print copies of the grid below. Have learners re-locate the cards under the proper headings.

Worker				
Supervisor				
Employer				

Cut out the Roles and Responsibilities cards. Re-locate them under the proper headings.





4. Asking Questions

Who do you ask?

If you don't know how to do something, or if you are not sure the work is safe, ask someone. Here's who you can ask:

- your supervisor
- your trainer
- your safety and health representative
- a co-worker

When do you ask?

- When you don't know how to operate a machine.
- When you don't know how to handle a chemical product.
- When you don't know what protection you should use.
- When you don't know how to use your protective equipment (PPE).

How do you ask?

Interrupt politely. Do you have a minute? Could I ask you a question? Practice using the right tone of voice and ask your teacher if your tone is correct.

Use courteous question forms like the following:

Could you tell me how to use this machine?

I don't think I know enough about this machine. *Could I have more training?*

I'm not sure how to use this product.

This product has a WHMIS label. *Is it safe* to handle?

Do I need to use goggles?

What safety equipment should I use?

Can you help me put on this equipment?

Does this mask fit properly?

Are these the right kind of gloves?

Activity 2: Asking questions about safety issues (role play).

Print and cut out the cards below. Distribute the cards and have students ask questions. The instructor or one of the stronger students can play the role of supervisor or Safety and Health Representative.

Be sure to give feedback on the student's tone of voice and body language. How do they initiate the question? Will they be perceived as aggressive?

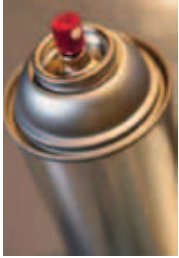

You have to clean up your machine before you go home. You see a spray can at your work station. You think it is used to clean the tools but you are not sure. There is no label on the can.



You always use rubber gloves for your work. One day you get some new gloves but you find that they don't fit properly.

Your supervisor does not have time to answer your questions. You want to talk to the Safety and Health Representative but you don't know who the Safety Representative is.



At your work station, there is a pulley that doesn't have a guard. You are afraid that you will catch your clothing in the pulley.



In Storage you notice that some chemical has spilled on the floor. It has a strong smell. You are not sure what to do.



The plug on your hand tool is frayed. You want a new cord put on the tool.



You see a sign showing a hard hat. You are not sure what it means. You do not have a hard hat.



The area where you work is dusty. Your eyes are sore and you want to wash them. Find out where the eye-wash station is.



The label on the cleaner you are using says you should consult the MSDS sheets. You don't know what MSDS sheets are or where to find them.



You have been working at your job for two weeks. You are not sure if you are doing everything right. Find out from your supervisor if your work is satisfactory.



Your supervisor tells you to clean up a contaminated area at the back of the factory. He tells you to wear a respirator, but you don't know how to put it on.

Add your own relevant examples.

Activity 3: Vocabulary review

There are many ways to do matching activities with lists of synonyms. Here are a few possibilities.

- To have learners work individually, make a matching exercise by jumbling the words in one of the columns.
- Cut out all the cards and have pairs of learners match them up.
- Enlarge the sheets and pin up the right hand column on the board. Cut out the cards in the left hand column and distribute to the learners. Have them go to the board and stick up their vocabulary word next to its synonym. This can be done in small groups posted around the room to encourage discussion of the vocabulary.

In all cases encourage learners to say the words aloud as they do the activity. If you are not sure that they understand certain words, have them make sentences to demonstrate the meaning.



danger	hazard
work it out	solve the problem
firm	assertive
maintain	clean and repair
take part	play a role
employer	boss
make sure it doesn't happen	prevent
to be aware	to know about
procedure	how we do things
group of representatives	committee
point out	indicate

5. The Right to Refuse

You have the right to refuse dangerous work.

It's hard to say no to your boss or supervisor. But you should say no if you think work is dangerous.



Your Rights

If you think that your work is dangerous, talk about it with your boss or supervisor. Usually, you can work it out. But sometimes, your boss may insist.

If you need to refuse, be polite but firm. The law gives the steps that you and your boss **must** follow.

If you don't
think it's safe,
don't do it!

Step One

Worker Refuses

If you decide to refuse a task, you must report your refusal to your supervisor or employer.

Step Two

Worker Representative is called

Step Three

Supervisor investigates

Your supervisor or employer must investigate your concern in front of you and the worker representative. If your supervisor or employer agrees the work is dangerous, it is corrected. You return to work.

Step Four

Workplace Safety and Health

Usually, you, your supervisor and your worker representative will be able to solve the problem. But if you can't, the Workplace Safety and Health Division (WSH) is called. The WSH inspector will investigate and help correct the problem.

While you wait for the inspector's investigation, your employer can give you other work to do.



Activities: Polite but firm!

When you feel that work is not safe and you need to say no, it is going to be difficult. Keep these things in mind:

You must get your supervisor's attention. You may have to speak more strongly than usual to make sure your supervisor listens to what you have to say. Here are some things you can say:

(Jim), I have to talk to you. It's important.

It's important you look at this. It isn't safe.

(Jim), I want you to check this right away because I can't work in these conditions.

If you cannot get your supervisor's attention, you can speak more strongly:

I have to refuse to work until this is fixed.

Know what you are going to say. Prepare your refusal so that your request is clear but doesn't seem impolite.

(Jim), I was given these gloves but they are not the right size. I can't work with these long fingers getting in the way. In the supply room they don't have any other size and they told me to work without gloves. That's just not safe.

I have a problem. Now that it's winter, they tell me this door must always be closed. That means that the ventilation system doesn't work. The fumes are really strong. By the time I go home my throat and nose are sore and I'm coughing. This is not safe!

I don't know how to operate this machine. I have never used a machine like this before.

Propose solutions. Before you refuse to work, see if you can work out a solution.

I can work at something else until the new gloves get here.

We could install a fan above the door to ventilate the room.

I need to be trained before I use this machine.

Create and practice dialogues between worker and supervisor that might occur in your workplace. Be aware that it is easy for language learners to sound aggressive or too passive. Get the instructor's feedback on the tone of your refusal.

If it's not safe,
don't do it!

Activity 4: Refusing work, jumbled dialogue

Cut out and jumble these sentences. Have learners put them back in an appropriate order.
(Hint) Jim is the supervisor.

Jim, I have to talk to you.

**Not right now, OK?
I have a meeting with the Safety and Health committee.**

Well, this is important. I really can't work like this.

What's the matter?

**I've been having trouble with this guard.
It keeps coming loose and it's not safe.**

I'll look at it this afternoon, OK?

**The brace on the guard is broken so there is only
one screw holding it. It really needs a new guard.**

I told you, I'll look at it this afternoon.

**Jim, I've talked to you about this before.
I'm sorry, but I can't work on a machine that is not safe.**



Activity 5: How to refuse work, reading a flowchart

Shapes in a flowchart show the different kinds of decisions in a process.

In this flowchart:



1. An upside down triangle is used at the beginning of a process:



2. A rectangle is used for an action by the employee.

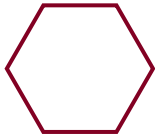

3. A hexagon is used for a question.

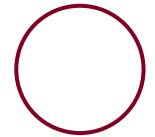

4. A circle is used for a decision.

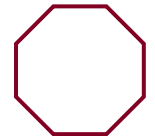

5. An octagon is used when the process is finished.

Now look at the flowchart and answer the following questions.

1. What process is being documented in the flowchart?
2. Who starts the process?
3. What is the first step?
4. What happens if the employee believes the job is safe after step 1?
5. What happens if the employee does not believe the job is safe after step 1?
6. How many different people can the employee talk to in order to solve the problem?

Flowchart: How to Refuse Dangerous Work

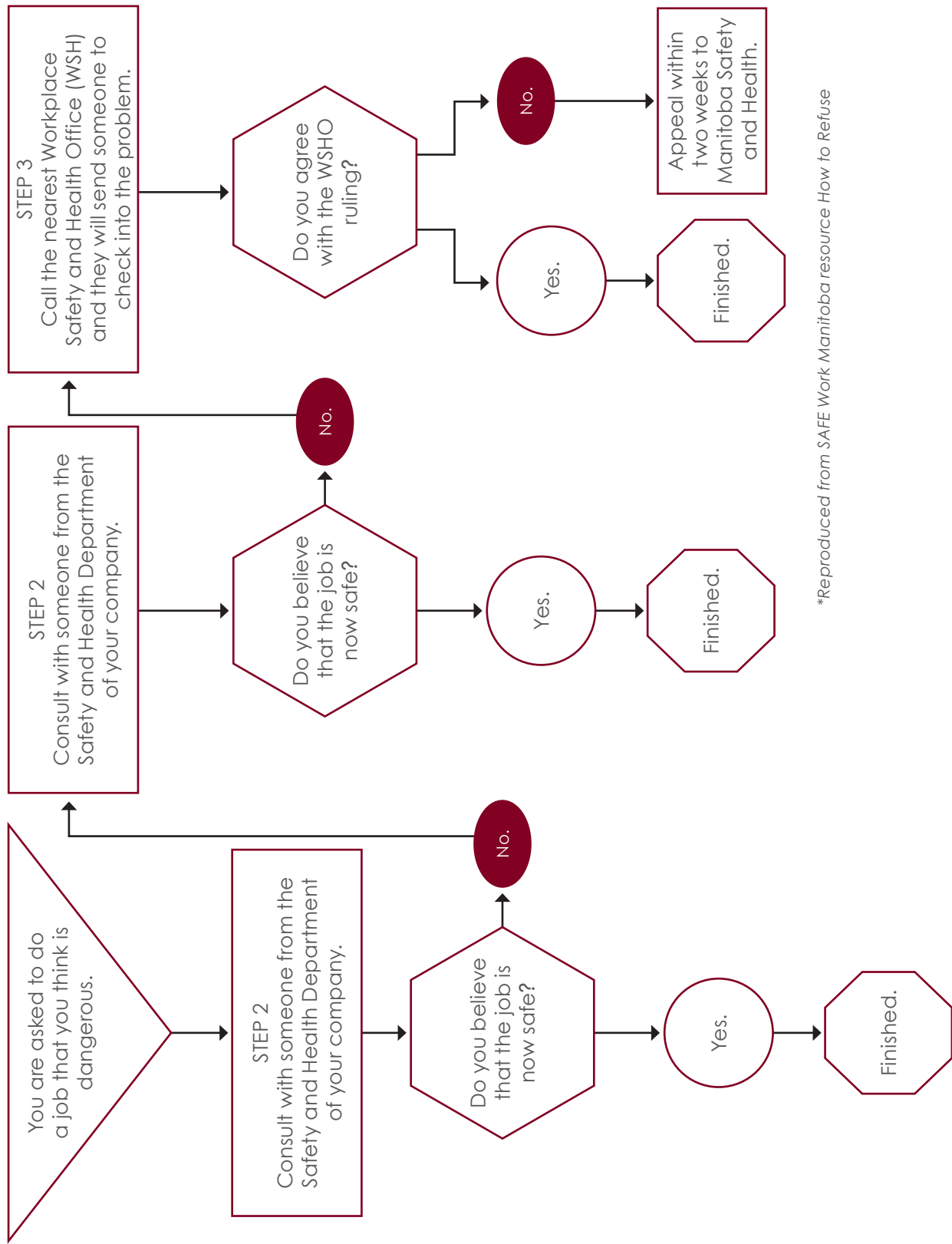

*Reproduced from SAFE Work Manitoba resource How to Refuse



MODULE 3

WORK HAZARDS

MODULE 3: WORK HAZARDS

This module will prepare learners to fully understand and participate in Module 3, Work Hazards, on the Health and Safety 101 website. To access the website go to www.safemanitoba.com/programs.

If learners need help navigating the website, walk them through Getting Started.

Language Objectives for Work Hazards

- Identify and describe the different types of workplace hazards.
- Become familiar with Hazardous materials terminology and WHMIS.

Vocabulary

injury acute injury chronic injury damage	Physical Biological Ergonomic Chemical Psychosocial	WHMIS MSDS labels symbols
corrosive biohazard inflammable explosive poisonous toxic reactive oxidizing	irritation, irritate rash, burning cough allergy, allergic respiratory ventilation	avoid prevent protect contact expose, exposure transmit



Types of workplace injury

Acute injury happens in a moment:



Broken bones



Cuts and bruises



Burns



Sprains

Chronic injury happens over time:



Hearing loss



Backache



Repetitive strain



Cancer

Activity 1: Read and match. What type of hazard is it?

Print out copies of the Hazards definitions for each student and make several sets of Hazards cards.

Group learners at tables of 4 or 5. On the whiteboard or overhead write up the different types of hazards, Physical, Chemical, Ergonomic, Psychosocial and Biohazards.

Give each table a set of Hazard cards. Ask learners to look through the pictures and group them by type of hazard represented.

Full group: make columns on the board with hazard types as headings. Invite learners to stick pictures in the appropriate column giving their reason.

Small groups: Ask students to sort the cards according to category and then report to the class what hazards they have chosen for each category.

Take note of any vocabulary that has special relevance to individual learners in their workplace. Always encourage discussion.

Physical hazards include unsafe machines and environmental conditions.

Examples are unguarded machine parts like saw blades, constant noise, or high exposure to sun or cold.

Biological hazards are produced by living things. They often come from working with animals and people. Examples include blood, viruses and animal and bird droppings.

Chemical hazards include materials that are flammable, explosive or poisonous. Examples are cleaning products, pesticides and gasoline.

Ergonomic hazards are caused by poorly designed workplaces or processes. Examples are poor lighting, or a job that requires you to repeat the same movement over and over.

ALSO—**Psychosocial factors:** Stress, conflict with co-workers, violence, poor working conditions, work overload.



Activity 2: Hazards in different jobs

Jobs and hazard categories

This exercise is to encourage learners to think about the hazards in a wider range of jobs and to provoke discussions about which types of hazards are the most significant. On the board have students make five columns with the hazards headings *Physical, Biological, Chemical, Ergonomic and Psychosocial*.

Lay the jobs cards face up on the table. Ask a small group of students (4 or 5) to work at the board. They must choose a job and, with blue tac, stick it under the column heading where they think it belongs. For example, a hydro linesman meets with physical hazards. Encourage lots of discussion of which jobs fit best under which headings. Some jobs may involve more than one type of hazard.

While one group is doing this at the board, the other learners can be working on flipchart paper at their tables. Ask them to sort the cards according to the type of hazards they face. Encourage discussion and note how the team works out problems. What do they do when a worker is exposed to more than one type of hazard? Do they feel they need to create sub-groups?

When the groups are finished, they can challenge the choices of the group that worked at the board.

Job Hazards: Mini presentations

Cut out and lay the cards, face up on a table. Ask learners to select a card representing a job they have done in the past or may do in the future. If they have never worked, ask about jobs done by family members or other kinds of work they are familiar with.

Have each learner present the job he/she has selected, describe, briefly, the work they do and talk about at least three hazards they might encounter on the job. They might then invite questions about safety from the others students in the group.

Keep a record (on a small note pad) of the difficulties each presenter met with (new vocabulary, phrases or pronunciation) and give these notes to the presenter after the presentations.

This can also be done as a poster presentation (see activity 3 below) where learners look for their own pictures and texts related to a particular job and present their information. Tell learners to leave blank space around the poster pictures to add more pictures and text about staying safe when they do the next module.







Activity 3: Integrated skills – making and presenting a hazards poster

Ask students to choose a job and a picture that illustrates it. They may go to clip art or elsewhere to find a good illustration or they may choose one from the clip art selections like those above and enlarge it. Have them mount their picture on a large piece of paper.

Ask the learners to place labels, pictures or drawings around their picture to indicate what hazards this person faces at work.

Reading: Help learners research the safety issues connected with a job of their choice on the internet. A Google search with the name of the occupation and the words Health and Safety will give many results. Provide safety brochures from Manitoba Workplace Safety and Health and fact sheets from Manitoba Federation of Labour - Occupational Health Centre.

They can also find many of the occupations discussed at the CCOHS site
<http://www.ccohs.ca/oshanswers/>

Writing: Have learners write brief notes about the hazards to attach to the poster.

Presenting: Have learners present their poster to the rest of the class. Provide this outline:

- What tasks does the person do at work?
- What kinds of hazards do they deal with? (Physical, Biological, etc.)
- Describe the hazards.

Follow up: Explain that you will talk about accident prevention and safety precautions next day/week. Materials can then be added to the poster and the (new, improved) presentation can be delivered again. If the job is relevant to their real life situation, the repetition will be beneficial.

Discuss the hazards that might affect the workers in additional jobs that were not chosen for the posters and presentations. Focus especially those that might seem very safe such as office work or retail. (Consider eyestrain, repetitive strain the possibility of robbery and violence.)

Now go to Health and Safety 101 and view screens 1-8 of Module 3, Hazards.

1. WHMIS: Workplace Hazardous Materials Information System

WHMIS is all about hazardous materials.



These jugs contain dangerous materials. Would you know how to handle them?

In many workplaces chemicals are used. They are often **concentrated** and stored in **large quantities** so they are more dangerous than similar chemicals used in the home.

In Canada, the Workplace Hazardous Materials Information System, or WHMIS, protects workers and makes them aware of the dangers.

WHMIS consists of four parts:

- a system of symbols
- labeling requirements
- MSDS sheets (Materials Hazards Data System) which clarify hazards
- and on-the-job training



WHMIS symbols

Do you already know the meaning of some of these symbols? You will soon know them all!



WHMIS product labels

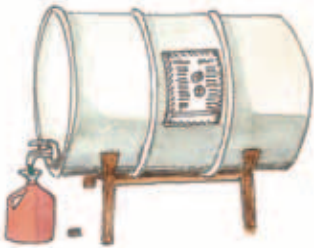

When Chemical products arrive from the **supplier**, they are usually in large containers. The product is poured into smaller containers that are easy to handle.

The **Supplier Label** gives a lot of information about the product.

Chemical name of the product.

The hazards.

The protection you should use when you handle this product.

What you should do in case of an emergency.

Name and address of supplier.





A **Workplace Label** must be placed on the new Container. The label must show:

- the name of the chemical
- the hazards
- where to refer to the **MSDS sheets** to find more information about handling the product
- and dealing with emergencies



When you need more information about any chemical product you are using, look for the MSDS Sheets.

They are usually kept in a binder in a place where you can find them easily.

Training

Classroom Training











On-the-job training



Your training will teach you how to read the WHIMS symbols, labels and MSDS sheets you will need at your job. You will learn how to handle the materials safely and what to do in case of emergency.

Activity 4: What are the WHMIS symbols and what do they represent?

	Compressed Gas	Material can explode.
	Flammable and Combustible Material	Can burst into flame very suddenly.
	Oxidizing Material	Will feed any fire, making it hotter and larger.
	Poisonous and Infectious Material: Immediate and serious toxic effects	Will cause acute and serious poisoning.
	Poisonous and Infectious Material: Other toxic effects	Can cause slow poisoning or other illness.
	Poisonous and Infectious Material: Biohazardous infectious materials	Can infect you with a serious illness.
	Corrosive Material	Can seriously harm your eyes and burn your skin or lungs.
	Dangerously Reactive Material	May explode if mixed with other chemicals or dropped.







Make cards with the contents of columns 1 and 3. Have students complete the table.

	Compressed Gas	
	Flammable and Combustible Material	
	Oxidizing Material	
	Poisonous and Infectious Material: Immediate and serious toxic effects	
	Poisonous and Infectious Material: Other toxic effects	
	Poisonous and Infectious Material: Biohazardous infectious materials	
	Corrosive Material	
	Dangerously Reactive Material	

Memory strategies

- Read through the table marking key words and making associations that will help learners remember the meaning of each symbol. R—React. Or the spidery shape of the biohazard symbol reminding you of insects and other living things (whatever works!) Follow up with the exercise completing the table (above). Jumbling the cards forces learners to read carefully.
- Group the symbols in different ways, for example, those that are poisonous and those that are explosive, and determine how they differ from one another.
- Make associations with familiar materials. For example, did you know that Wite-Out was inflammable and corrosive?
- Cut up and reassemble the table to test understanding of the symbols and the terms.
- Enlarge the WHIMS symbols most relevant to your students and post them at the top of columns on the board. Have students place pictures or text associated with each symbol in the column. Some clip art pictures are found throughout this module. Later you will be learning about how to protect yourself from these products, so save space in the column to add information.

			
POISONOUS	FLAMMABLE	BIOHAZARD	CORROSIVE



Effects of hazardous materials

These symptoms sometimes indicate the presence of hazardous materials.

 <p>headache</p>	 <p>vomiting</p>
 <p>dizziness</p>	 <p>rash</p>
 <p>cough</p>	 <p>sore eyes</p>

Activity 5: Reading a WHMIS Label

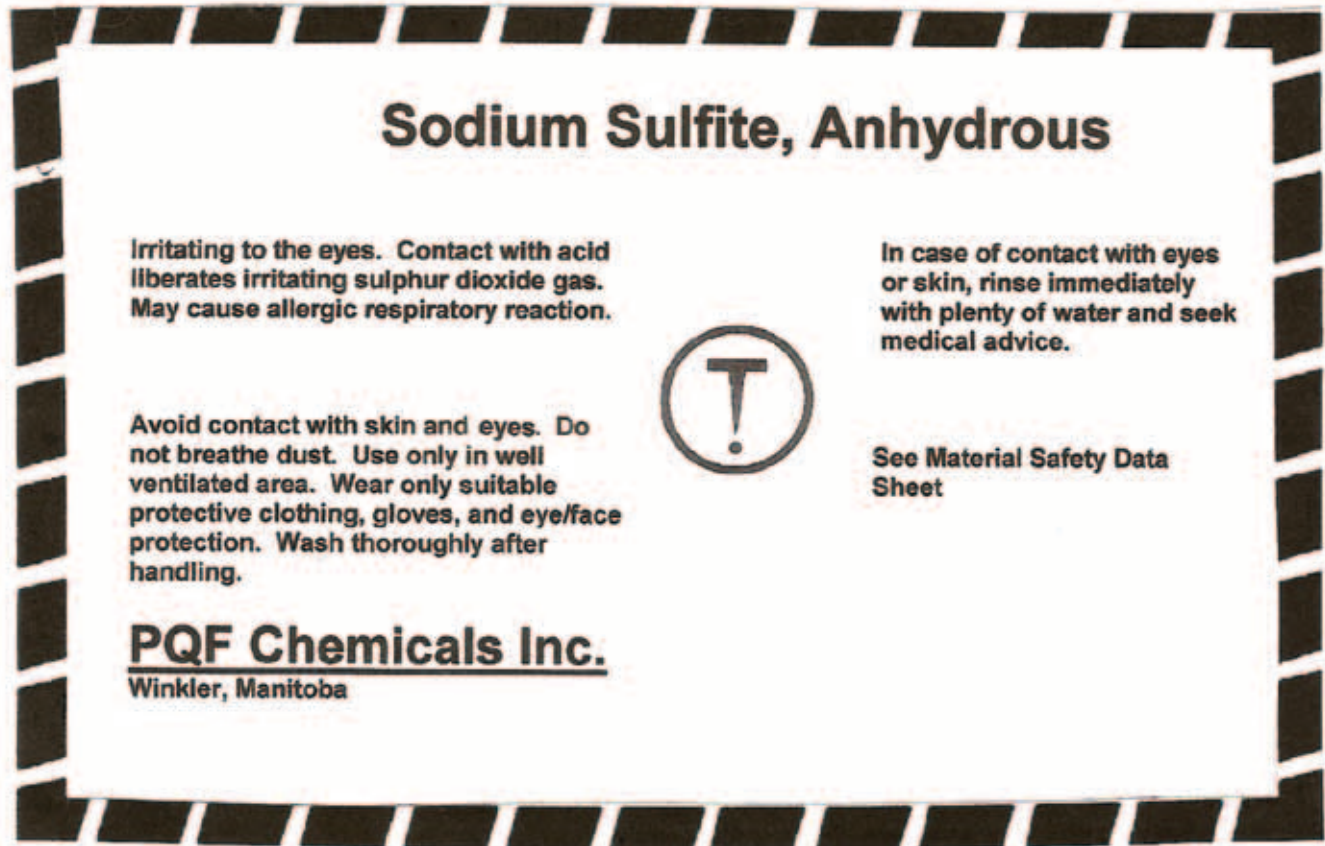

Find and circle these parts of the label:

1. Name of the Material
2. WHMIS symbol
3. Why the material is dangerous
4. How to protect yourself
5. What to do in an emergency



Activity 6: Reading – Material Safety Data Sheets

Amy saw a WHIMS Label on a cleaning product she was using. She wanted more information so, she got the MSDS binder. She looked up the product in the binder but she didn't understand the sheets. She went to find her supervisor and asked him.

The supervisor gave Amy a lot of information about how to handle the product.

Here is some of what he said:



This product is toxic.



It might make you cough.



You must wear protective equipment when you use it.



You should wear a mask, gloves and an apron.



You must not smoke when you are handling this material.



If you feel dizzy, open the window.

Make up a role play for Amy and her supervisor.

Activity 7: Lists game

The objective of the activity is to broaden the learners understanding of safety issues and to increase their ability to talk about them.

This game is played like “Categories”. It can be played individually, in pairs or in groups. If the lists are made individually, more writing will be required of each student. If students work in groups, they will be able to brainstorm and discuss.

The instructor gives an occupation as a topic heading. The task is to write as many hazards as you can think of associated with this job. Students have 2 minutes to think and write.

Example: The instructor says, “A cook in a fast food restaurant”, the students will try to write down as many hazards as possible associated with this job. One student (or group) reads their list aloud and the others cross off any of the entries that are the same on their lists. The list that has the most “unique” entries, that is to say, entries that no other players wrote down, is the winner of the round.

Allow for plenty of discussion and argument. For example, they may not agree on whether being locked in the cold storage room counts as one hazard or two (cold and confined space).

Did learners have trouble thinking of hazards? See the “Summary” on the following page.



Summary

Food preparation and service involves many safety and health hazards. Important ones are listed in the table below.

Injury	Illness Source
Cuts and amputations	Use of knives, cutters, slicers, choppers and grinders
Burns and scalds.....	Contact with open flames, hot oils, steam, ovens, appliances, utensils
Electric shock, electrocution	Kitchen appliances Cleaning equipment
Slips and falls.....	Slippery and cluttered floors Inadequate lighting
Soreness and loss of	Repeated awkward movements or vibration
function of wrists and arms	Working in one position for a long time
Back pain	Heavy lifting involving awkward postures and difficult loads
Itching, swelling, redness.....	Temperature extremes; physical abrasion; of skin exposure to detergents, cleaning solutions, food additives, some plant materials, pesticides on fruits and vegetables
Coughing, wheezing,	Exposure to flour, grain dust, spices, additives
shortness of breath	

This list of the hazards involved in food preparation comes from the manual “Food Service Workers Safety Guide” published by CCOHS (Canadian Centre for Occupational Health and Safety.)

For information about other occupations go to <http://www.ccohs.ca/oshanswers/>

Activity 8: Sean's story

Distribute the Handout for Activity 4. The reading will introduce the story that can be seen on video in Health and Safety 101.

Pre-listening: Read about how the incident happened

This is a story about an incident that killed a young man named Sean. Sean was pouring chemical from a large drum into a smaller can. The chemical was very inflammable, but there was no label on the drum. An electric spark ignited the fumes. The fire spread immediately and Sean was covered in flames. He had burns all over his body. He managed to live for 24 hours.

Watch Sean's Story on screen 9, Part 3, Work Hazards of the Health and Safety 101 website.

Watch as often as you need to. Click on the Text button to read the whole story. Now answer the questions on your handout.

Handout for Sean's story

Read the Introduction.

You are going to hear a story about an incident that killed a young man named Sean.

Sean was pouring chemical from a large drum into a smaller can. The chemical was very inflammable, but there was no label on the drum. An electric spark ignited the fumes. The fire spread immediately and Sean was covered in flames. He had burns all over his body. He lived for only 24 hours.

Watch Sean's Story on screen 9, Module 3, Hazards, on the Health and Safety 101 website.

Watch as often as you need to. Click on the Text button to read the whole story. Now answer the questions.

Quiz

1. Who is telling the story?
 Sean Sean's father Sean's boss
2. How did the story end?
 Injury Illness Death
3. Were the containers labeled?
 Yes No
4. What label should have been on the containers? Choose the appropriate label:
   
5. Who is responsible for putting the correct labels on chemicals?
 the employer the supervisor the worker

Quiz Answer Key

1. Who is telling the story? **Sean's father**
2. How did the story end? **Death**
3. Were the containers labeled? **No**
4. What label should have been on the containers? Choose the appropriate label: **Flammable**
5. Who is responsible for putting the correct labels on chemicals?
the employer | the supervisor | the worker

It's everyone's responsibility to spot hazards and make the workplace safe.



MODULE 4

WORK HAZARDS

MODULE 4: WORK HAZARDS

This module will prepare learners to fully understand and participate in Module 4, Work Safely, on the Health and Safety 101 website. To access the website go to www.safemanitoba.com/programs.

If learners need help navigating the website, walk them through Getting Started.

Language Objectives for Work Safely

- To identify different ways of avoiding hazards.
- To learn the names of personal protective equipment (PPE).
- To recognize emergency situations and respond to them.

Vocabulary

Machine guards locking out eliminate hazards	Vapour, fumes, gas Ventilation Inhale—breath in	Emergency procedures Fire extinguisher Evacuate
Negatives: Incorrect Inappropriate Improper unhealthy unsafe illegal	Redesign Eliminate—get rid of	Personal Protective Equipment respirator, face shield, goggles, earplugs, earmuffs, coveralls

1. Controlling Hazards

The best way to prevent injuries is to get rid of the hazard. Of course, it is not always possible to do that.

We can also control hazards.

i. Physical Hazards

Machine Guards

Machines with moving parts can catch your clothes and pull you in. Some machines also have sharp blades. These machines should have guards to prevent injuries.

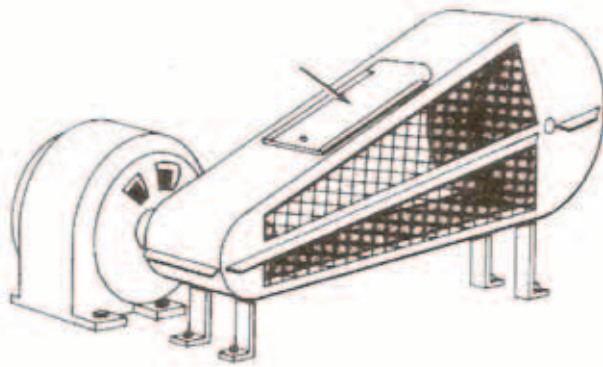

Guard on a pulley

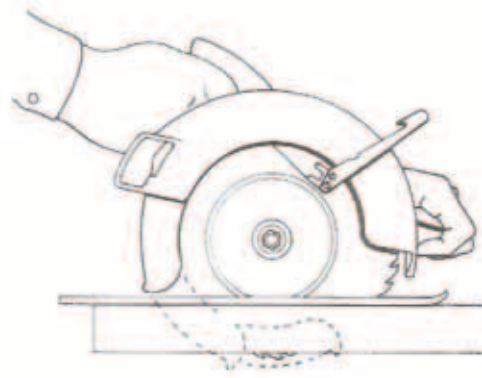

Guard on a saw blade



Lockout

When machines are being cleaned or maintained, they should be **locked out**.

Locking out ensures that the machine cannot operate while someone is working on it.

Read the information on the tag.

Danger. Do not operate.

This lock/tag may only be removed by:

Name _____

Dept _____

Expected Completion _____

Activity 1: Hazard alerts

www.worksafebc.com has a large collection of Hazard Alerts that describe and illustrate incidents that have happened recently in the workplace.

Here is one example (the English has been slightly modified for this exercise). Encourage learners to visit the site to read about safety issues in their chosen occupation.

Have a volunteer take the role of Safety and Health Representative and “report” the incident to the class.

- Describe how the incident happened.
- Use an enlarged version of the picture to show the panel and the switch.
- Give safety recommendations for the future.

HAZARD ALERT

Industry: Bakery **Age:** 32 yrs **Experience:** 6 months **Area:** Lower Mainland

Baker's arm caught in bread dough machine

A baker was working on the bread line when he noticed that dough balls were sticking. He took off a cover panel without turning off the power to the machine. He then reached through the conveyor chain. His arm was caught, resulting in broken bones and severe cuts.

Safe work practices:

- Do not remove guarding that protect workers from moving parts while the machinery is in operation.
- Shut down and lock out moving parts before servicing machinery or doing maintenance and repairs.
- Instruct workers in lockout and other safe work procedures for the tasks they perform.



WorkSafe
WORKERS' COMPENSATION BOARD OF BC

The WCB has a wide range of safety and health information. For assistance and information on workplace safety and health, call toll-free within BC 1-888-621-SAFE (7233) or visit our web site at www.worksafebc.com.

**INJURY
04-03**



ii. Chemical Hazards

Get rid of toxic products by choosing non-toxic substitutes.

Toxic Product



Safe Product



When possible, use products that are not harmful to your health. The best solution is to have no hazardous materials in the workplace. If the hazard can not be avoided, it may be controlled in different ways:

- Barriers that prevent the hazard from coming into contact with the worker, such as good ventilation
- Training and Supervision
- Good work procedures
- Personal Protective Equipment

Forms of ventilation:

Open window



Fan

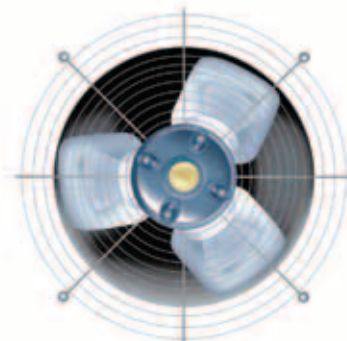

Ventilation system



iii. Ergonomic Hazard Control

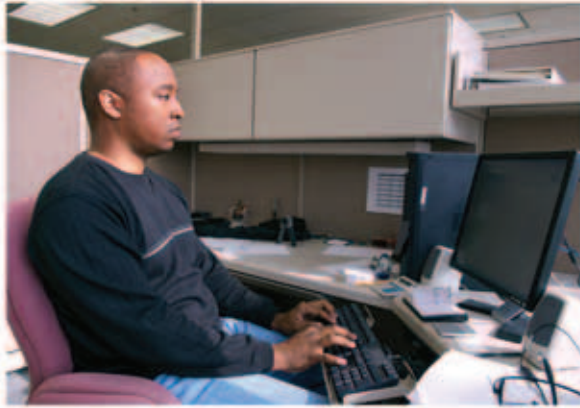

This table and monitor are at the right height for the operator.



Use proper work procedures. This man has not learned proper lifting and he may hurt his back.



Avoid awkward lifting and stretching. Store heavy items on lower shelves and use ladders or mechanical lifts.



Take breaks from work that requires repetitive movement. Cashiers and office workers suffer from repetitive strain injuries.



iv. Biological Hazard Control

In some workplaces, especially in the health care sector, there are always biological hazards. Health care workers have to follow strict work procedures, for example, gloving and frequent hand washing.



Gardeners, landscapers and farmers wear proper clothing to protect themselves from hazards like insect bites, animal droppings and poisonous plants.



2. Protecting the Worker

When the hazard can not be controlled, the worker is protected by personal protective equipment or PPE. These cards will make you familiar with many different types of PPE.

Activity 1: Card games with PPE

The names of different PPE can be hard to pronounce, so oral games and drills with this vocabulary are important. Print and cut out the cards and save the sets in envelopes.





They can be used in many ways:





- Lay out all the cards and have pairs or small groups assemble the triads. Have the learners make sentences with the three parts:
 - I wear safety glasses to protect my eyes from dust.
 - Safety boots prevent slipping.
 - A mask keeps fumes out of my nose, throat and lungs.

Play versions of *Fish* in small groups. For example deal out the body parts cards and spread the pictures of the PPE on the table face down. Player one says to another player, "I need (gloves) to protect my hands. Have you got any?" If the second player has the card he must give it up. If he doesn't have it he tells the first player to "Go fish!" Player one tries to draw the piece he needs from the cards on the table. If he is successful in matching the two cards, he gets another turn. If not, he must put the card back on the table face down, and the next player takes a turn.



Using only the body parts cards, have one student draw a card and then ask the others "How do you protect your (hands)?"















	<p>Gloves</p>	<p>Hands</p>
	<p>Earmuffs</p>	<p>Ears</p>
	<p>Earplugs</p>	<p>Ears</p>
	<p>Safety Shoes</p>	<p>Feet</p>
	<p>Work Boots</p>	<p>Feet</p>

	Goggles	Eyes
	Face Shield	Face
	Mask	Nose and Mouth
	Respirator	Nose, Throat and Lungs
	Apron	Clothes



	<p>Coveralls</p>	<p>Skin</p>
	<p>Safety Glasses</p>	<p>Eyes</p>
	<p>Rubber Gloves</p>	<p>Hands</p>

Activity 2: Safety equipment review

-  protect my _____ from loud noise.
-  protect my _____ from chemicals, dust and flying things.
-  protect my _____ from loud noise.
-  protect my _____ from chemicals, dust and flying things.
-  protects my _____ from flying things.
-  protects my _____ from fumes.
-  protect my _____ from cuts.
-  protects my _____ from chemicals or food.
-  protect my _____ from heavy weight.
-  protects my _____ from going into the machine or into the food.
-  protects my _____ from dust.
-  protects my _____ from falling things.

Used with permission from Work Start.



Activity 3: A problem in the lab

There are three rules about safety equipment:

1. They must control the hazard.
2. They must not create a new hazard
3. They must allow you to work comfortably.

The workers in a laboratory are given rubber gloves to protect them from the biohazards in the lab. However the gloves do not fit well and the workers find it hard to handle the small samples they are working with. As a result, there are more spills and broken containers. This is creating more hazards. Many of the workers say the gloves are awkward. They prefer not to wear the gloves at all, so they are not following safe procedures.

In this case the PPE is not effective. What is wrong?

How do the gloves fail on all three counts?

Who is responsible?

3. Emergency!

Open up a discussion about what constitutes an emergency. Encourage learners to talk about emergency situations they have lived through. Discuss emergency plans that they have in the home.

Do activities that practice the language you need in an emergency.

Activity 4: Talking about emergencies

	<p>fire serious spreading fire department</p>		<p>explosion oxygen tank fire evacuate</p>
	<p>gun demanding money evacuate police</p>		<p>weather snowing and blowing stranded close down</p>
	<p>barrel leak smell label don't touch!</p>		<p>injury fall broken bleeding first aid ambulance</p>

Cut out the emergency cards and fold back or stick the vocabulary lists on the backs of the corresponding picture cards. Have learners describe an emergency using the words on the back of the card.



Activity 5: Reporting an emergency

Your supervisor is trained to know what to do in case of an emergency. When you see something happening that you think might be an emergency, contact your supervisor right away.

Read and practice the following dialogues.

Fire!

Worker: Hello, is that Juan?
Juan: Yes, Juan speaking.
Worker: Juan? We need you in the woodworking section. There's a fire.
Juan: Is it serious?
Worker: It's mostly in station five but it's spreading. I think we should call the fire department.
Supervisor: I'll be right there!

Extreme Weather

Worker: Hello Mandy. Have you looked outside?
Mandy: Why? What is it?
Worker: It's blowing really hard. The parking lot is drifting in badly.
Mandy: Do you think we'll get stranded here?
Worker: We might. You'd better come and have a look.

Explosion!

Worker: Hey Orson! There's been an explosion in the warehouse.
Supervisor: What exploded?
Worker: One of the canisters they were unloading.
Supervisor: What was in it?
Worker: I think it was oxygen.
Supervisor: Make sure everybody's ok! I'll be right there.

Chemical Spill

Worker: Bill? Is that you? Could you come down to storage please?
Bill: What happened?
Worker: One of the barrels fell and it leaked all over the floor.
Bill: What's in it?
Worker: I don't know but it smells bad.
Bill: Ok. Don't touch anything until I get there.

Injury

Worker: Juan, there's been an incident on the site.
Supervisor: What happened?
Worker: Johnson fell off the ladder.
Supervisor: Is he hurt?
Worker: I think he broke his ankle and his knee is bleeding.
Supervisor: Is there anybody there with first aid?
Worker: Yeah. (Hamal) is here. He says we need an ambulance.
Supervisor: Ok! I'm calling 911.

Violence!

Worker: Peter! There's a man with a gun in reception.
Supervisor: What's he doing?
Worker: I don't know. He's pointing the gun at (Lisa). I think he's asking for money.
Supervisor: Lock the doors and evacuate the front office. Get everyone into the back. I'm calling the police!



Activity 6: Finding Safety Features

Where can you find these safety features in your building? Take note of where each is located.



Emergency Exits



Fire extinguisher



Fire Alarm



First Aid Station

Practice asking and answering questions about finding safety equipment. Use these expressions:

- Can you tell me where the fire extinguisher is?
- I'd like to know about emergency procedures.
- Could you show me where the first aid station is?
- Excuse me. Could you show me how to use the (eyewash station)?

Activity 7: Reading and Talking Preventing Injuries

When an injury occurs, we need to look at how we can prevent it from happening again.

- Read this story and discuss how the injury could have been prevented.
- Have students think of recommendations for using the pasta machine.
- When they are finished, compare with Safe Work Practices below.

The owner of a pasta company was placing ingredients in a pasta machine. As she reached into the hopper, the sleeve of her blouse was caught in the rotating mixing arm. As the mixing arm continued to turn, her hand was broken.

Safe work practices:

- Do not wear loose clothing when working on or around machinery.
- Keep hands away from moving parts when adding ingredients.
- If you must reach inside the equipment to service machinery, first shut down and lock out moving parts.



Picture, story and safe work practices from Hazard Alert, www.worksafebc.com. English has been slightly modified for this exercise.



4. What to Do When You are Hurt

1 - Get first aid

- Know where the first aid station is located.
- Know who has training in first aid.

2 - Tell your supervisor

- Make sure your supervisor knows what happened.

3 - Get medical help if you need it

- Your supervisor or employer will arrange for you to be sent to a doctor or to a hospital for treatment if necessary.
- Tell your doctor that you were hurt at work.
- Phone your boss to let him know what the doctor told you.
- If you receive medical care, you must file a claim with the Workers Compensation Board.

4 - File a claim

- You and your employer will file a claim if you needed medical attention. You may also be off work or need more medical attention later, so it is important to file a claim with WCB.

5 - Keep in touch

- Keep in touch with your employer while you are off work. Let him know what your doctor is saying.

What is the difference between first aid and medical care?



- First Aid is given in the workplace by a co-worker who is trained to give very basic medical help.
- Medical care is given in a fully equipped clinic or hospital by trained doctors and nurses.

Activity 8: What to do when you are hurt at work

Use the picture story to clarify the steps to be taken in case of injury at work. Clear the right hand column and have students write dialogues for each picture.



Andy was hurt at work. He cut his arm badly.



**He went to the First Aid station right away.
His co-worker, Heather, bandaged his
arm and she told him he should see
a doctor right away.**



Andy went to his supervisor and told him what had happened. His supervisor called the office and arranged for a car to take Andy to the hospital.



Andy told the doctor that he was hurt at work. He needed several stitches and the doctor told him to stay home for a couple of weeks.

Workers Compensation Board of Manitoba
 To report your work injury, please CALL: 954-4755 (Toll-free 1-800-954-4755)
 Or Fax the form to: Box 4998, (248) 500-1177 (T-1-877-5262), 333 St. James St. Winnipeg, R2C 3K9

WORKER INCIDENT REPORT
 Claim No. 3

Worker Information
 Last Name: _____ First Name: _____
 Address: _____ City: _____
 Province: _____ Postal Code: _____ Telephone: _____
 Date of Birth: _____ SS No.: _____
 Gender: Male Female

Employer Information
 Business Name: _____ (If different from above, please specify)
 CUS: _____ Province: _____ Telephone No.: _____

Incident Details
 Date of Incident: _____ Amount of Injury: _____
 Date Reported to Employer: _____ Name and position of person to whom incident was reported: _____
 Please describe the incident in as much detail as possible. (Use separate sheet if necessary. If applicable, identify any witnesses.)

After he had seen the doctor, Andy filed a claim with the Workers Compensation Board of Manitoba.

Andy filled out Form 3 to be sure he had all the information. Then he called 954-4999 to file a claim.



He stayed home until his arm was better. He kept in touch with his boss and told him what the doctor recommended.

Activity 9: Filing a claim

The purpose of this exercise is to demystify the Claim Form to some extent, and to give the worker a sense of what information is needed when they file a claim.

- Which questions can you not answer?
- How can you find out the answers?

Workers Compensation Board will help you file a claim by phone.



To report your claim faster, please CALL:
954-4100 (Toll-free 1-800-362-3340)
 or fax this form to:
 954-4999 (Toll-free 1-877-872-3804)
 333 Broadway • Winnipeg R3C 4W3

WORKER INCIDENT REPORT

Claim No. _____	3
-----------------	----------

Worker Information

Last Name		First Name		
Address				City
Province	Postal Code	Telephone No. ()	Date of Birth DD / MM / YYYY	PHIN
Social Insurance Number	Male <input type="checkbox"/> Female <input type="checkbox"/>	Job Title		

Employer Information

Business Name		Address (include Branch where applicable)		
City	Province	Postal Code	Telephone No. ()	

Incident Details

Date of Incident DD / MM / YYYY	Area(s) of Injury
Date Reported to Employer DD / MM / YYYY	Name and position of person to whom incident was reported.
Please describe the incident in as much detail as possible. (Use separate sheet if necessary. If applicable, identify any witnesses.)	
City and province where incident occurred.	
Did the incident occur on your employer's premises? <input type="checkbox"/> yes <input type="checkbox"/> no If no, specify name and address of premises where incident happened.	

Name and Address of Doctor(s) and/or Hospital(s) that Provided Treatment (Attach separate sheet if necessary)

Name	Address	Date of Visit DD / MM / YYYY
Name	Address	Date of Visit DD / MM / YYYY

Time Loss & Wages (Only complete this section if you have missed time from work beyond the date of the incident)

What was the last day and hour you worked following the incident?	DD / MM / YYYY at HOUR <input type="checkbox"/> AM <input type="checkbox"/> PM
Have you returned to work? <input type="checkbox"/> yes <input type="checkbox"/> no If yes, when?	DD / MM / YYYY at HOUR <input type="checkbox"/> AM <input type="checkbox"/> PM
Were you paid wages by your employer while you were off work? <input type="checkbox"/> yes <input type="checkbox"/> no	Do you have other sources of employment income? <input type="checkbox"/> yes <input type="checkbox"/> no
How many hours do you work per week? If it varies, please describe.	What are your regular days off? If it varies, please describe.
What is your current hourly wage? \$	What are your regular gross earnings? (Specify weekly, bi-weekly, etc.) \$
What is your marital status? <input type="checkbox"/> Single <input type="checkbox"/> Common-law <input type="checkbox"/> Married <input type="checkbox"/> Separated <input type="checkbox"/> Divorced	If married/common-law, is your spouse/partner working? <input type="checkbox"/> yes <input type="checkbox"/> no
Are you personally allowed to claim a deduction on your current year Income Tax Return for:	
Dependant children age 18 years or younger? <input type="checkbox"/> yes <input type="checkbox"/> no	If yes, how many dependants? _____
Disabled dependants age 18 years or older? <input type="checkbox"/> yes <input type="checkbox"/> no	If yes, how many dependants? _____
Child care expenses? <input type="checkbox"/> yes <input type="checkbox"/> no	If yes, estimate total deduction for current tax year \$ _____
Child support payments? <input type="checkbox"/> yes <input type="checkbox"/> no	If yes, state monthly amount \$ _____ Total for the year \$ _____
Spousal support payments? <input type="checkbox"/> yes <input type="checkbox"/> no	If yes, state monthly amount \$ _____ Total for the year \$ _____
Have you applied for income from other sources? (e.g. EI, CPP, Social Insurance, Co. Disability Plan, etc.) <input type="checkbox"/> yes <input type="checkbox"/> no If yes, please describe.	

WCB 2007

For Faster Claim Reporting, Please Call 954-4100

Aussi disponible en français

Worker's Name	Claim No.	3
---------------	-----------	----------

Coverage

Was anyone not employed by your employer involved in the incident? <input type="checkbox"/> yes <input type="checkbox"/> no	If yes, give name and address.
Are you a partner, director or sole proprietor of the company? <input type="checkbox"/> yes <input type="checkbox"/> no	
Are you a sub-contractor? <input type="checkbox"/> yes <input type="checkbox"/> no	If yes, specify: <input type="checkbox"/> construction <input type="checkbox"/> logging (Complete appropriate sections below)
Are you an owner operator? <input type="checkbox"/> yes <input type="checkbox"/> no	If yes, specify: <input type="checkbox"/> courier <input type="checkbox"/> trucking <input type="checkbox"/> towing (Complete appropriate sections below)
Please answer these questions if the incident occurred between Jan. 1, 1992 and Dec. 31, 2005	
Are you a member of the family of your employer (or a director of the corporation if your employer is a corporation)? <input type="checkbox"/> yes <input type="checkbox"/> no	
If yes, do you reside with the employer or director? <input type="checkbox"/> yes <input type="checkbox"/> no	

Sub-Contractor or Owner Operator: (only complete if you are a sub-contractor or owner operator)

Is your employer covering you under their WCB coverage? <input type="checkbox"/> yes <input type="checkbox"/> no	If no, are you registered with WCB? <input type="checkbox"/> yes <input type="checkbox"/> no
Do you work in a partnership? <input type="checkbox"/> yes <input type="checkbox"/> no	Do you employ other workers? <input type="checkbox"/> yes <input type="checkbox"/> no

Sub-Contractor in Construction

Do you supply any materials or equipment? <input type="checkbox"/> yes <input type="checkbox"/> no	If yes, please specify.
--	-------------------------

Sub-Contractor in Logging

Do you supply any materials or equipment? <input type="checkbox"/> yes <input type="checkbox"/> no	If yes, please specify.
Were you cutting on the firm's timber sale, timber permit or sawmill license? <input type="checkbox"/> yes <input type="checkbox"/> no	If no, on whose timber sale, timber permit or sawmill license were you cutting?

Owner Operator is a Courier

What is the gross vehicle weight? (This can be obtained from the Autopac registration)
--

Owner Operator in Trucking

Do you haul within a 16 km radius of the city or town in which the home terminal is located? <input type="checkbox"/> yes <input type="checkbox"/> no	Are you a long distance driver? <input type="checkbox"/> yes <input type="checkbox"/> no
Do you provide a vehicle? <input type="checkbox"/> yes <input type="checkbox"/> no	If yes, how many vehicles do you provide?

I understand that under *The Workers Compensation Act* the WCB can collect information about me to adjudicate and manage my claim and that information from my claim may be disclosed to my employer or employer representative for WCB program purposes, or may be released to others as authorized by legislation, including *The Workers Compensation Act*, *The Personal Health Information Act* and *The Freedom of Information and Protection of Privacy Act*. The information collected may be used to conduct WCB evaluations and surveys.

If you have any questions regarding the collection, use or disclosure of information on your claim, please contact the WCB's Access and Privacy Officer at 954-4557 or toll free at 1-800-362-3340 extension 4557.

Release for Medical Information

I authorize persons in possession of medical and other information that the WCB determines relevant to this claim to release same to the WCB upon request.

Release for Income Information from Canada Customs and Revenue Agency

This is your authorization to provide the Workers Compensation Board of Manitoba with copies of my complete income tax return(s) and other taxpayer information including all supporting information slips, schedules and financial statements. The information will be used:

- (1) to assist in establishing my net average earnings and
- (2) to determine and verify eligibility for benefits under the Workers Compensation Act.

This authorization is valid for the two taxation years prior to the year it was signed, the year it was signed, and each following taxation year where benefits are provided.

Signature of Worker X	Date DD / MM / YYYY
---------------------------------	------------------------



Activity 10: Discussion of working safely

Review the methods of making the workplace safe.

1. Eliminate the hazard. Get rid of the danger.
2. Isolate the area where the hazard exists.
3. Limit the contact between the worker and the hazard.
4. Establish safe work procedures and train workers to follow them.
5. Protect the worker from the hazard.



This worker has been trained to move the patient properly and to use equipment to help prevent strain.



The supervisor is working closely with this new worker. She is able to observe that he is working safely and she is on hand to answer his questions.



Limit the time workers are in dangerous situations. Hydro workers limit the time they work outdoors in cold weather.



By wearing Personal Protective Equipment, workers can avoid many incidents. This worker is wearing a face shield to protect his face from sparks and flying dust. He is also wearing a fall prevention harness.

Activity 11: Vocabulary review (reading and writing)

Fill in the blanks using the words at the bottom of the page.

1. A hypodermic needle found in a washroom is a _____ hazard.
2. Blades and moving parts should be protected with _____.
3. When machines are being repaired they should be _____.
4. Good _____ will take away toxic fumes.
5. Your Health and Safety _____ meets to discuss safety issues.
6. Everyone has a _____ in keeping the workplace safe.
7. The Workplace Hazardous Materials Information System is usually called _____.
8. Extreme heat is considered a _____ hazard.
9. Ergonomic hazards can often be avoided by good work station _____.
10. Office workers often suffer from injuries caused by _____ movement.

guards
repetitive

design
biological

ventilation
physical

WHMIS
locked out

role
committee



Activity 12: Pictorial Vocabulary Review

Cut out cards, fold and stick the text behind the picture. Learners draw a card and look at the picture. They explain as much as they can about the picture.

Assess on three points:

1. How clear (and correct) is the information?
2. Is safety vocabulary used correctly?
3. Are sentences (and questions) well phrased?



The bottle contains a hazardous material and has a WHMIS label. The label tells what the hazards are, how to handle the product and what to do in case of an emergency.



This can has a workplace label, part of the WHMIS system, containing essential information about the contents of the can. It should refer the reader to the MSDS sheets.



MSDS binder where information about the hazards of specific chemicals are kept. Should be in an accessible place. Tells how to handle and store the product, what protection is needed, and what to do in case of an emergency.



Example of working safely. The machine has a guard. The worker is wearing PPE: hard hat, safety glasses, coveralls and work gloves.



Dangerous lifting!
Example of awkward reaching and stretching. This is an example of risky ergonomics. Warehouse workers should not lift and stretch at the same time.



Meeting of the Workplace Safety and Health Committee meeting. The committee is elected by the workers. They discuss any concerns that workers have and negotiate with management.



Worker handling biohazardous material. She is wearing a face mask, rubber gloves and goggles.

Options

- Cards can be cut out and folded so that the information is on the back. Students may work in small groups. They take turns choosing a picture to talk about. They can then compare their information with the information on the back of the card.
- Pictures can be enlarged and used to initiate group discussion and review.
- Writing: Erase the information in the right hand column and replace it with lines where students can write their comments.
- Listening for lower levels: Instructor reads the description and the students choose the picture.



